



Sylvie Saint-André Perrin

4, villa de l'Astrolabe
75015 Paris
tél. +33 1 47 34 85 91
fax +33 1 43 35 57 81

mise à jour du 30/08/07



Sylvie Saint-André Perrin
poterie, céramique

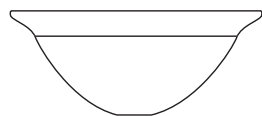

Jatte / Pasta Bowl

P.M. D. 19 cm, H. 6 cm

G.M. D. 21 cm, H. 6,5 cm

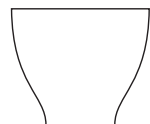

Gobelet / Goblet

D. 9 cm, H. 7,5 cm

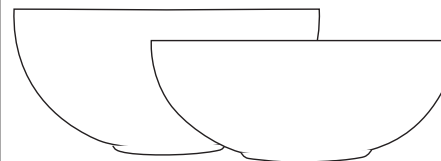

Bol avec talon / Bowl with talon

X.T.G.M.

T.G.M.

D. 17 cm, H. 8 cm

D. 17 cm, H. 7 cm

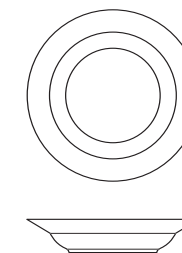

Porte bouteille / Bottle older

D. 15 cm, H. 2 cm



Coupelle / Small dish

D. 14 cm, H. 5 cm

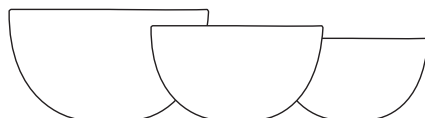

Bol sans talon / Bowl without talon

G.M.

M.M

P.M.

D. 14,5 cm

D. 12,5 cm

D. 12 cm

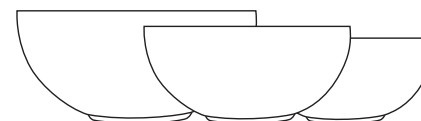

Bol avec talon / Bowl with talon

G.M.

M.M

P.M.

D. 14,5 cm

D. 12,5 cm

D. 12 cm

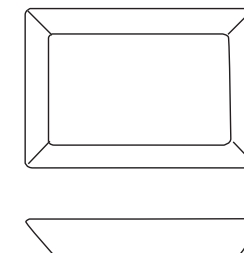

**Ravier / Hors
d'œuvres dish**

T. G.M. 33 x 22 x 2 cm

G.M. 20 x 16 x 2 cm

P.M. 17 x 13,5 x 4 cm



Bol "saké" / Bowl "saké"

D. 6,5 cm, H. 4,5 cm



Tasse avec pied / Cup with talon

D. 11 cm, H. 6 cm

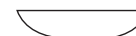

Porte savon / Soap dish

D. 11 cm, H. 2,5 cm

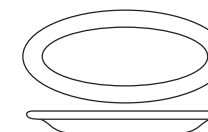

**Ravier ovale à tapas /
Oval hors d'œuvres dish**

17 x 12 cm

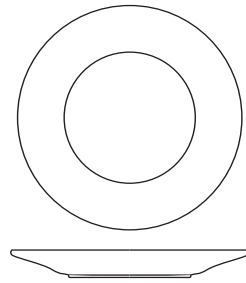

Assiette "Fabrizio" / "Fabrizio" plate
D. 24 cm, H. 2 cm

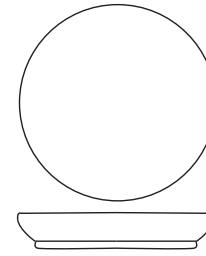

Assiette à dessert / Dessert Plate
D. 20 cm, H. 2,7 cm

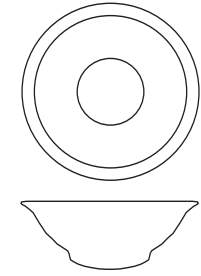

Plat creux rond / Deep round dish
D. 19,5 cm, H. 6,5 cm

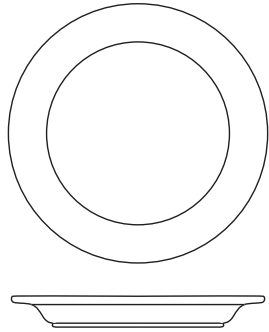

**Assiette de présentation /
Presentation plate**
D. 31 cm, H. 2,2 cm

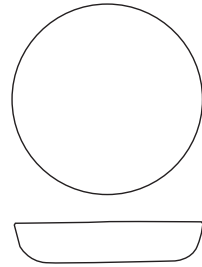

Assiette à bouillie / Small soup plate
D. 17 cm, H. 3,5 cm

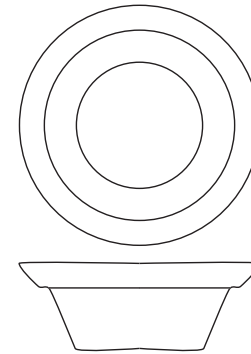

**Saladier "Mallorca" / Salad bowl
"Mallorca"**
D. 24 cm, H. 11 cm

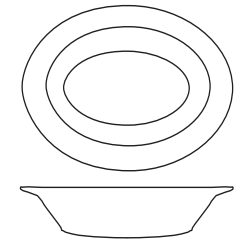

Plat creux ovale / Deep oval dish
24 x 19 x 5 cm

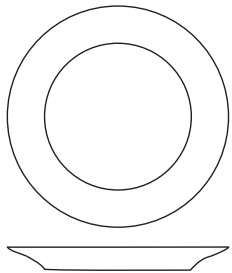

Assiette classique / Diner plate
D. 25 cm, H. 2 cm

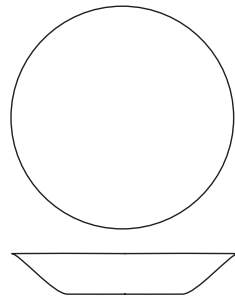

Assiette à soupe / Soup plate
D. 19,5 cm, H. 3 cm

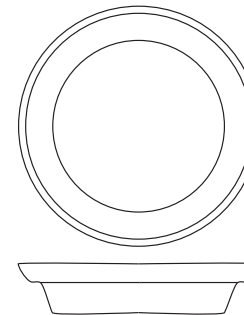

Plat "Mallorca" / Platter "Mallorca"
D. 30 cm, H. 6,5 cm

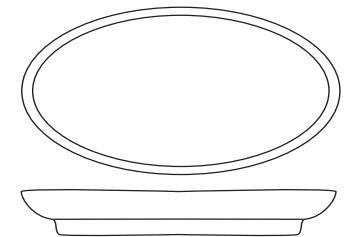

Plat ovale / Oval dish
31 x 18 x 2 cm

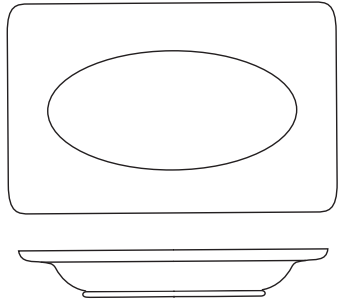

Plat rectangulaire / Rectangular dish
38 x 24 cm

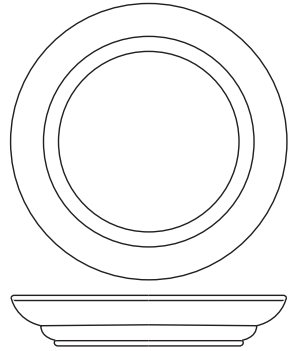

Plat rond / Round dish
P.M. D. 30 cm, H. 4 cm
G.M. D. 37 cm, H. 6 cm

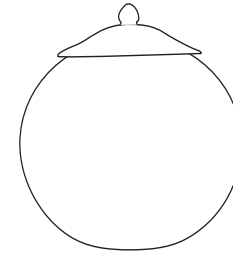

Boîte Boule / Ball box
D. 15,5 cm, H. 16,5 cm

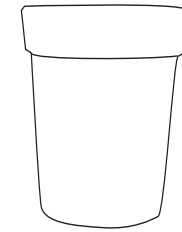

Vase / Straight vase
D. 15 cm, H. 16,5 cm



Coupe / Flat cup
D. 40 cm, H. 6 cm

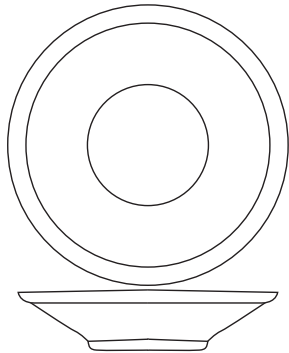

Plat rond T.G.M. / Round dish T.G.M.
D. 43 cm, H. 7,5 cm



Boîte ronde / Round box
D. 14 cm, H. 6 cm

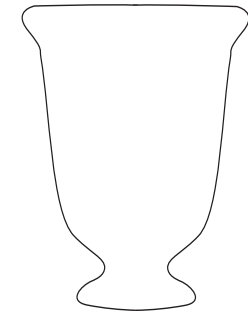

Vase Médicis / Medicis vase
D. 22,5 cm, H. 30 cm

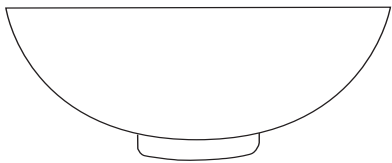

Coupe Dior / Dior cup
D. 27 cm, H. 9,5 cm

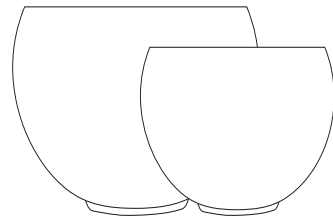

Vase "plumes" / Feather pattern vase
P.M. 14 x 13,5 cm
G.M. 19,5 x 19 cm

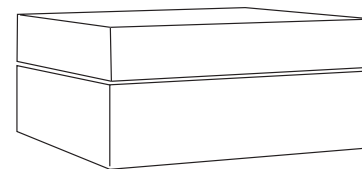

Boîte rectangulaire / Rectangular box
20,5 x 17,5 x 8,5 cm

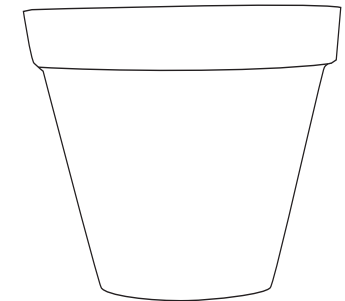

Cache pot / Flower pot holder
P.M. D. 31,5 cm, H. 27 cm
G.M. D. 36,5 cm, H. 31,5 cm

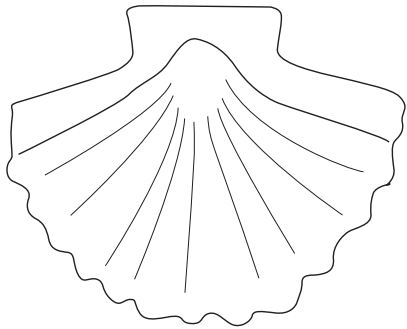

Coquille / Shell
32 x 28 x 4 cm

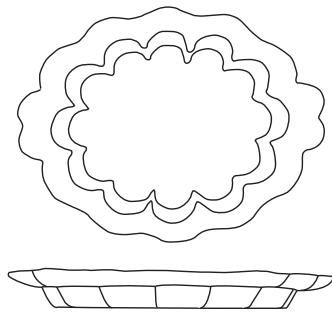

Plats à Oreillettes / Dish with festoon
P.M. 27 x 15 x 2,5 cm
G.M. 32,5 x 22 x 2 cm

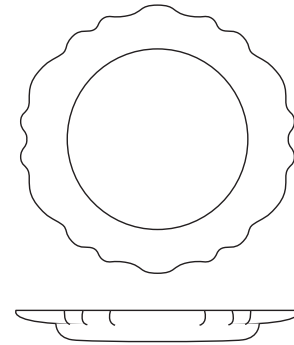

Assiette à Godrons / "Godron" plate
D. 29 cm, H. 2 cm

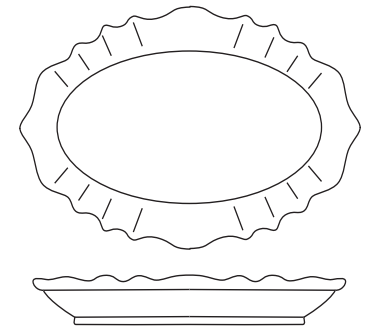

Plat Louis XV / Louis XV dish
43 x 35 x 4 cm

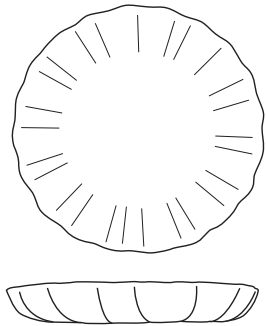

Plat rond / Round dish
D. 23 cm, H. 3,5 cm

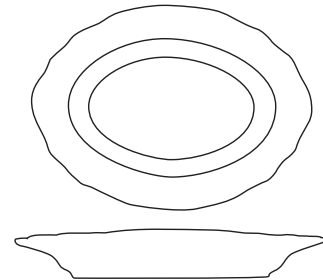

**Plat ovale "Moustiers" /
Oval dish "Moustiers"**
32 x 23 x 4 cm

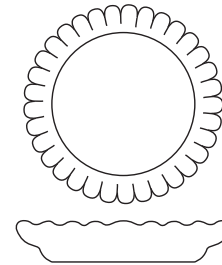

**Assiette à dessert xviii^e /
Dessert plate xviii^e**
D. 22,5 cm, H. 2,5 cm

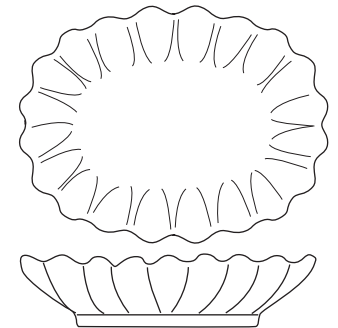

Plat portugais / Portuguese dish
P.M. 25 x 20 x 5 cm
G.M. 33 x 27,5 x 6 cm

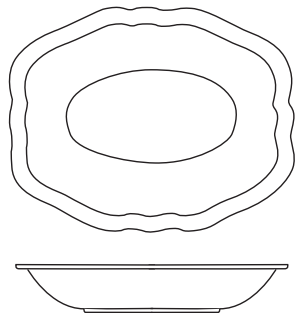

Légumier / Vegetable dish
26 x 20,5 cm

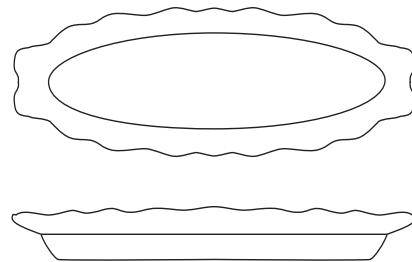

Plat à poisson / Fish dish
52 x 29 x 5 cm

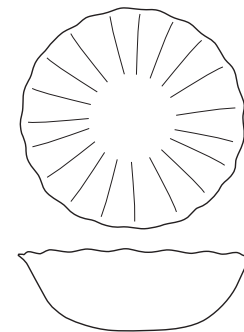

"Charlotte" / "Charlotte"
D. 24 cm, H. 7 cm

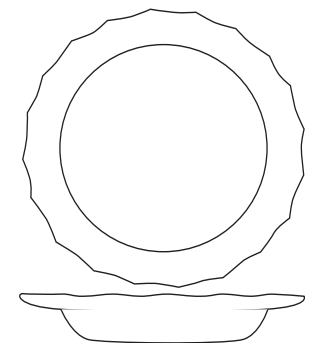

Plat rond G.M. / Round dish G.M.
D. 36,5 cm, H. 4,5 cm